

**Mercedes Sprinter CampTec Style
Extension package 2**

Installation instructions

Status: 25.10.2023

Art. No. 68604

JEHNERT
Sound Design
AUTOMOTIVE

Extension package 2

»68604 Subwoofer Underseat+ CampTec«

Modell/Baujahr: Transporter Mercedes Sprinter ab Bj. 2018
VS30 (Typ W907 / W910)



CampTec package 2 (item no. 68504):

1x Amp V40 CampTec incl. Molex connection cable
incl. 8x self-adhesive velcro pads

1x connection cable ISO speaker 1,0m (11181 without rear/11184 with rear connection)

1x Subwoofer Underseat 17028 incl. 165mm dual voice coil (e.g. mounting in the passenger seat)

1x Subwoofer mounting set:

4x self-adhesive Velcro pads 4x pan-head screw 3.5x 13mm

1x „plug&play“ subwoofer cable 3,3m

Required tools / accessories

- Phillips screwdriver
- Torx screwdriver TX25
- 10 mm open-end wrench
- Hot air dryer
- Gloves
- Plastic wedge
- Padding material for surface protection
- Unlocking tool for radio
- Tray, or similar to store small parts
- Flashlight
- Side cutter
- cordless screwdriver with 4mm drill bit and cross recess
- Insulating tape

Optional accessories:

- plug & play adapter for orig. Mercedes radio
f. Models without E3D interface
(Art. No.: 11080)
- Bluetooth module (Art. No.: 68497)
- rocker switch (Art. No.: 69499)
- Insulation package: 3x Alubutyl,
2x insulation fleece (Art. No.: 27970)

Garantie:

Als Hersteller übernehmen wir für diese Soundsysteme eine Garantie von 3 Jahren, gerechnet ab dem Kaufdatum beim Fachhändler. Innerhalb dieser Garantiezeit beheben wir nach unserer Wahl durch Reparatur oder Austausch unentgeltlich alle Mängel, die auf Material- oder Herstellungsfehlern beruhen. Von der Garantie ausgenommen sind Schäden, die auf unsachgemäßen Gebrauch oder Einbau, auf Verschleiß oder auf Eingriffe durch Dritte zurückzuführen sind.

Die Garantie umfasst keine Folgeschäden und auch nicht diejenigen Mängel, die den Wert oder die Gebrauchstauglichkeit der Soundsysteme nur unerheblich beeinträchtigen. Eine Garantiepflcht wird nicht ausgelöst bei Schäden, die durch äußere Einwirkungen verursacht wurden. Vom Umtausch ausgeschlossen sind Systeme mit zusätzlichen oder falschen Montagebohrlöchern. Dies sind Beschädigungen der Komponenten, die nicht wieder Instand gesetzt werden können.

General installation instructions - must be observed!



Power supply:

The amplifier must be supplied with a separate power supply to the body battery with a cable cross section of 4mm² and a fuse protection of the amplifier with 15A.



Radiosettings:

To achieve the best sound, all settings on the radio (bass, treble, loudness, equalizing, etc.) should be set to ZERO or OFF.

Installation Notice:

To avoid vibration noise, secure all cable harnesses with insulating tape or similar.

Basic settings amplifier



Set pushbutton to „HI“ (pressed)

1. Radio disassembly (only necessary if no Mercedes E3D interface (DSP preparation) is available)

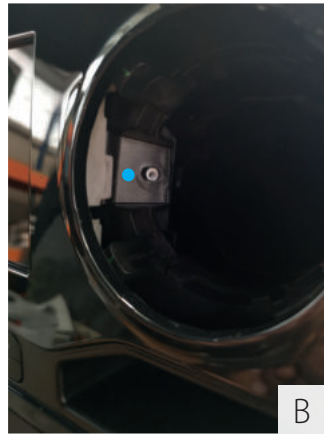

- Pull out ventilation nozzles forwards using a hook inside the radius (recess provided) on the left side. (see fig. A) ●
- Remove the screws behind the air vents. ●(see fig. B)
- Carefully pry out the radio console (display with frame) between the dashboard and the plastic trim with a plastic wedge, starting at the front. Starting at the front, disconnect the connector and remove the complete panel. ● (see Fig. C)

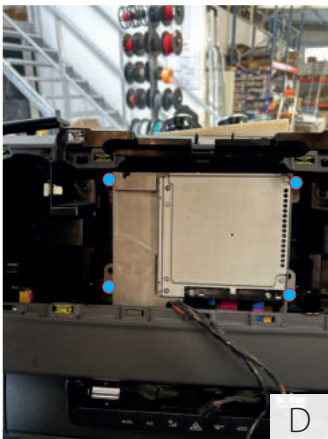

- Remove radio mounting screws (● ,4 pcs.), then remove radio. (see fig. D)
- Lay the Iso connection cable starting from the radio shaft to the amplifier mounting location. (see description of amplifier)
- Disconnect the connector plug from the radio ●(see Fig. E).

2. Connection radio adapter cable/ISO cable and amplifier

(only necessary if no Mercedes E3D interface (DSP preparation) is available)



- Connect radio connection cable (article no.: 11080) with the original radio plug ●. Connect opposite side to the radio ●.

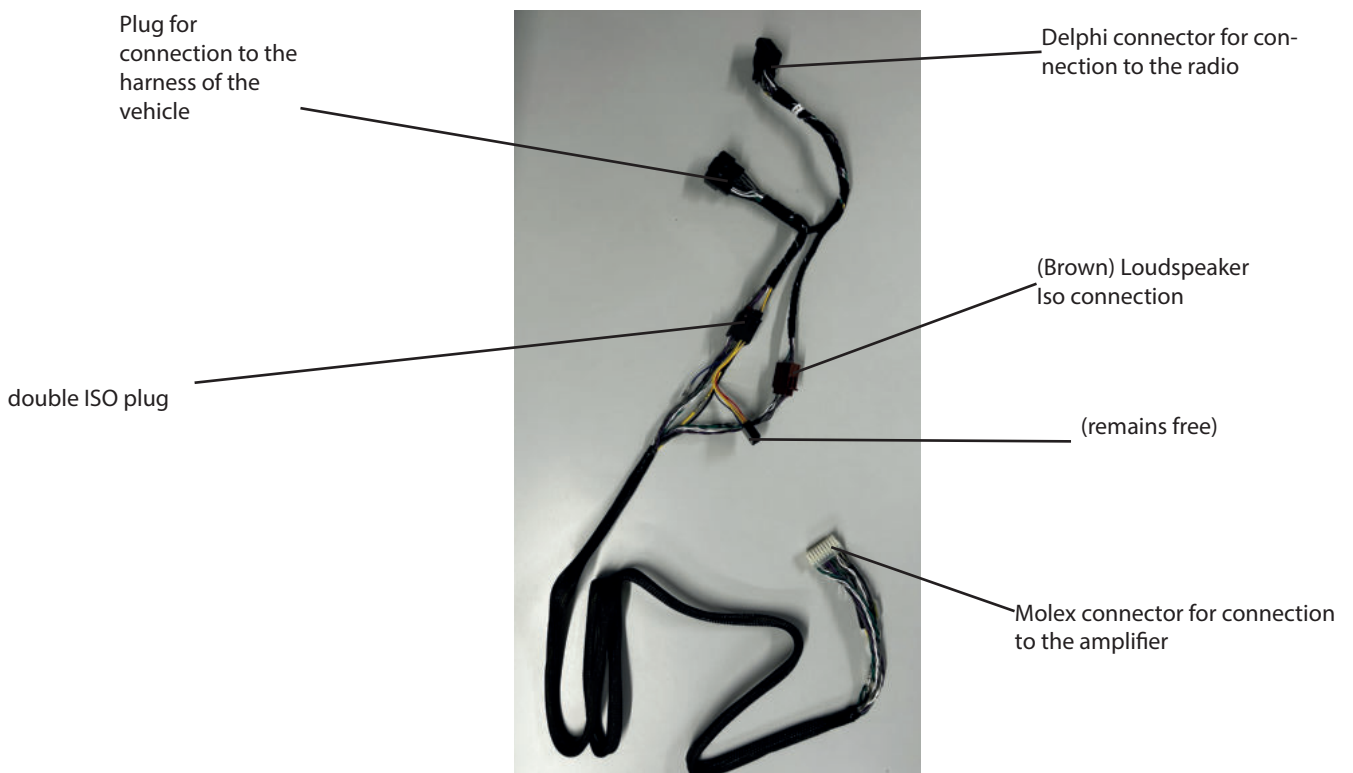



- Unclip and remove the beverage holder panel below the center console using a plastic wedge.

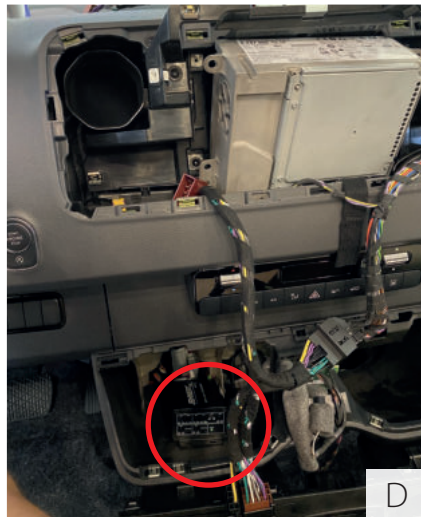
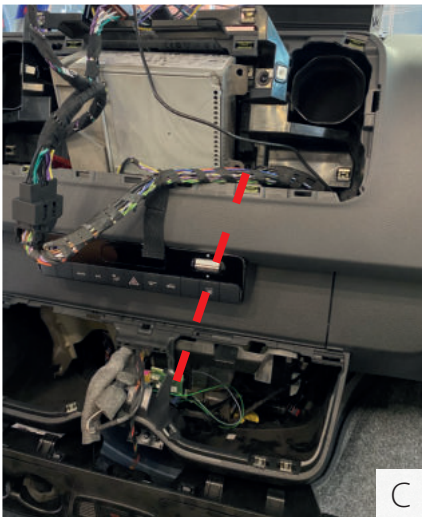

- Route the iso-cable from the radio behind the panel of the center console to the area behind the panel of the cup holder.
- Connect the amplifier to the iso cable via the pin connector and stow it behind the beverage holder panel.

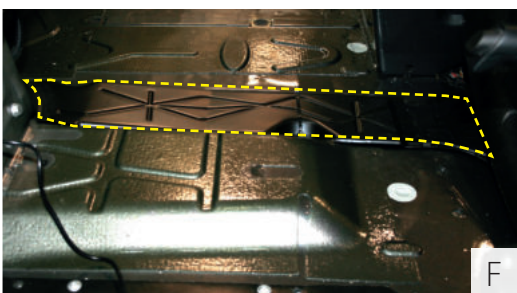

- Open the original cable grommet (cable shaft) in the footwell (Fig. F).
- Lay the 3.3m subwoofer cable from the mounting location of the amplifier via the cable gland to the subwoofer under the passenger seat.

3.1. Radio connection to Mercedes original connector (code E3D)

Connect original Mercedes plug to Iso wiring harness, only for vehicle incl. factory DSP interface E3D



The Mercedes ISO interface is located in the factory behind the trim on the passenger side - footwell. There the ISO cable for the amplifier can be adapted plug & play.

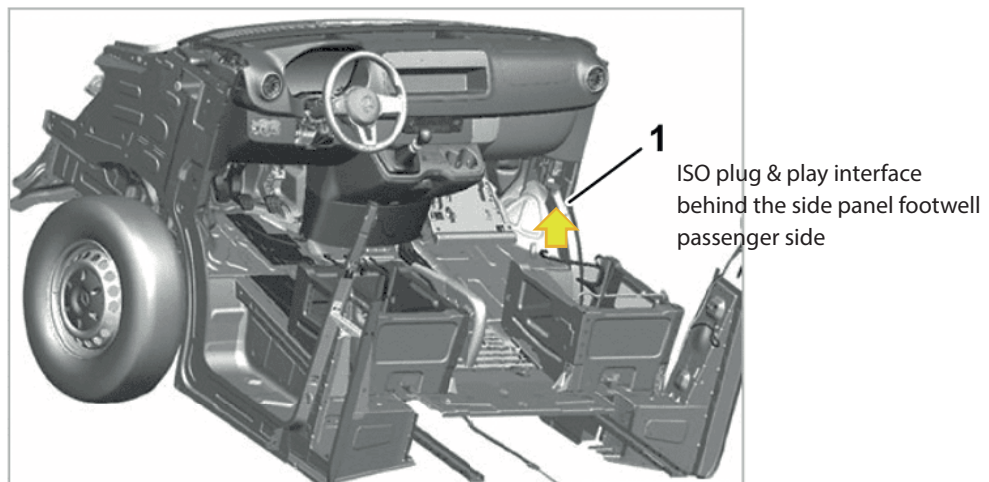

Note for Hymer models:

The Hymer DSP box is located under the passenger seat at the factory, the power supply for the TV is fed from this (connection 4-pin Molex plug with 3 blue wires). Therefore, the amplifier must still be operated for the power supply, alternatively the adapter cable / power bridge is available (Art. No. 68491)

The ISO cable as well as the jack cable can be reconnected from the previous DSP amplifier, so that only the power supply via the DSP is still guaranteed. Alternatively, a new power supply for the TV must be installed, or the above power bridge must be installed.

3.2. Radioanschluss für Modelle ohne E3D

- ISO-Connect ISO cable to the connected radio connection cable (Art. No.: 11080)

4. subwoofer mounting (under passenger seat)

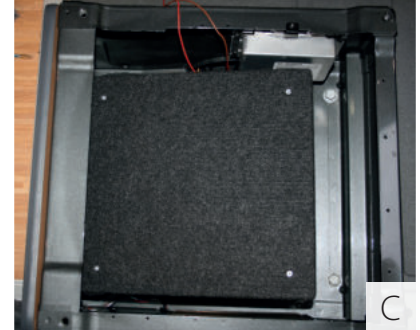
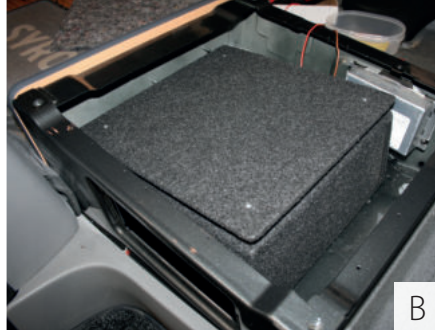

- Place the subwoofer housing appropriately in the seat console and leave enough space around it to the sides, otherwise vibrations and disturbing noises may occur.
- Connect the subwoofer cable (plug and play) to the connection terminal of the subwoofer.
- Fasten the housing to the floor using the supplied Velcro pads, or mount it to the seat bracket using an aluminum bracket (not included in the scope of delivery) to the seat bracket.

Pin assignment subwoofer connector:

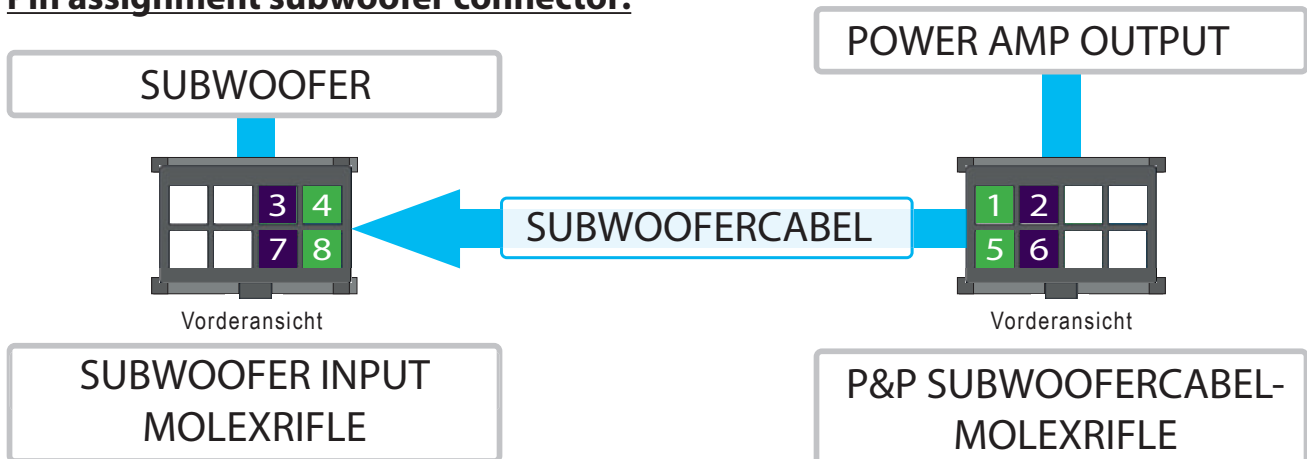

Pin assignment subwoofer input:

- Pin 4: Subwoofer channel **3** -
- Pin 8: Subwoofer channel **3** +
- Pin 3: Subwoofer channel **4** -
- Pin 7: Subwoofer channel **4** +

Pinbelegung P&P-Kabel Molexbuchse:

- Pin 1: Subwoofer channel **3** -
- Pin 5: Subwoofer channel **3** +
- Pin 2: Subwoofer channel **4** -
- Pin 6: Subwoofer channel **4** +

High-pass as well as low-pass filter settings must be adjusted to the respective technical specifications of the connected speakers.

Connection of 2x living room speakers & 2x woofer/1x subwoofer:

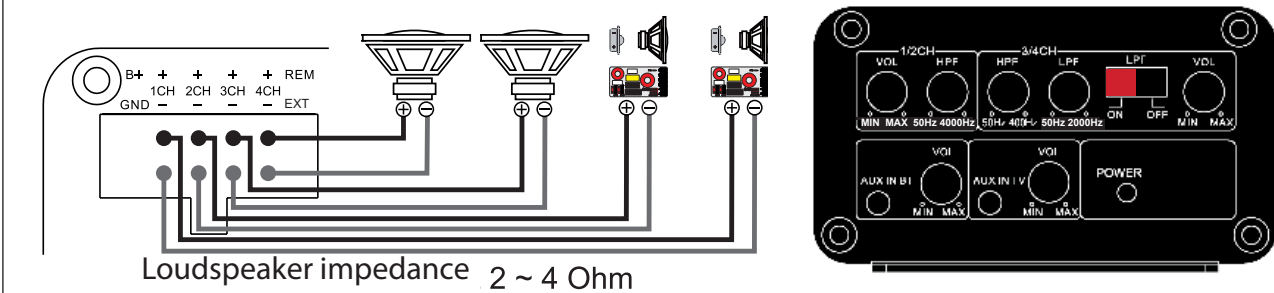

Loudspeaker impedance 2 ~ 4 Ohm

CampTec Style Ausbaumöglichkeiten

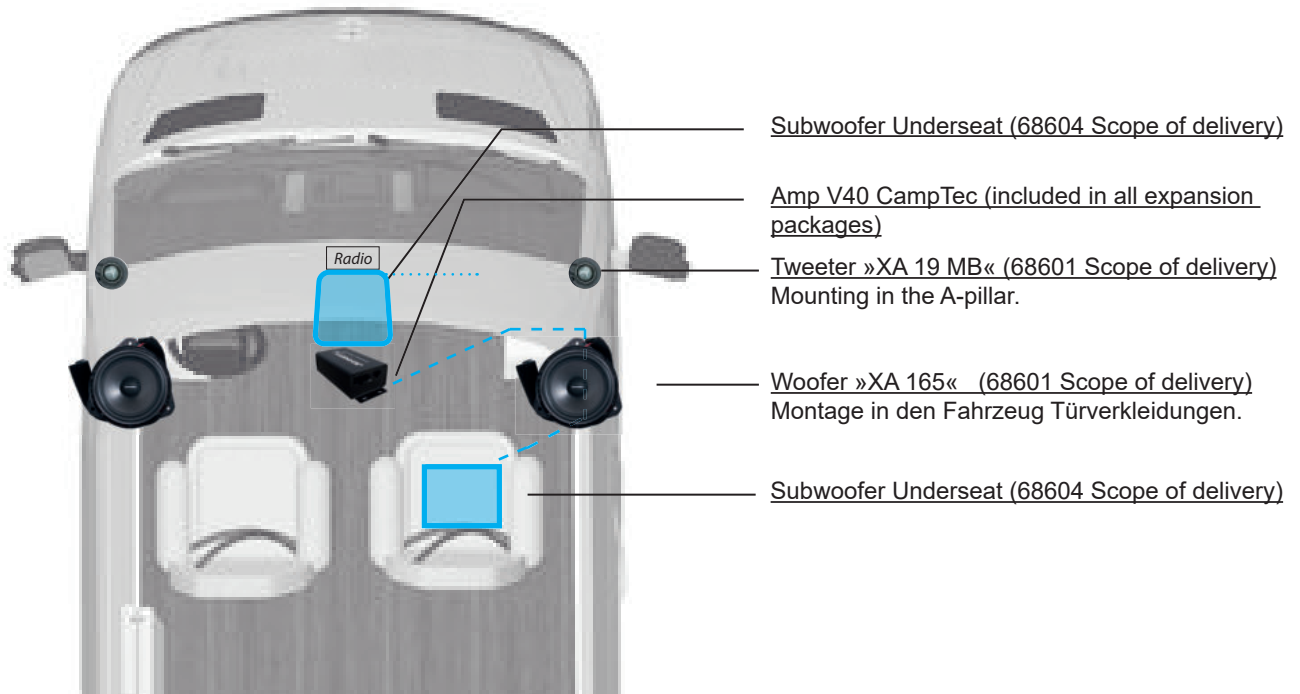

The 2-way front system CampTec Style can be optionally expanded with an amplifier and subwoofer (different versions selectable) to significantly increase the sound experience again.

If you have any questions, please do not hesitate to contact our team in Pliezhausen:

JEHNERT SOUND DESIGN

»Development and production of car audio systems«

Owner: Hans-Peter Jehnert
Im Michelreis 14
72124 Pliezhausen
Phone: 07127-93457-0
Fax: 07127 / 93457-10
sounddesign@jehnert.de
www.jehnert.de



Share your Sound Experience
with #JehnertSoundDesign



facebook.com/jehnersounddesign



Subscribe us on Youtube

